

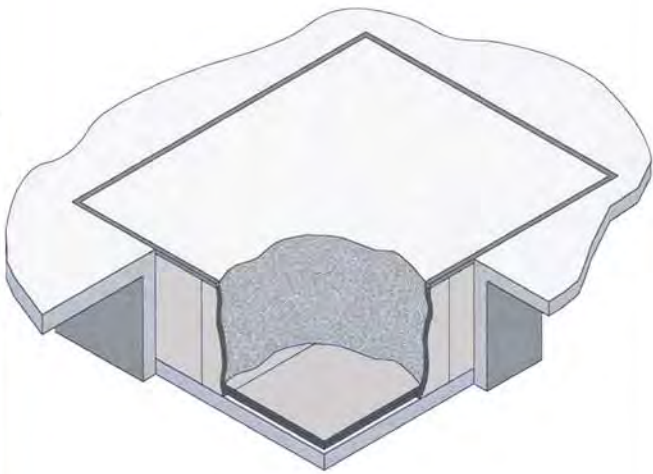

INSTALLATION TECHNOLOGIES

# FOUNDATION ISOLATION SOLUTIONS

**UNISORB IB-500™**



**UNISORB GK BLOCKS™**

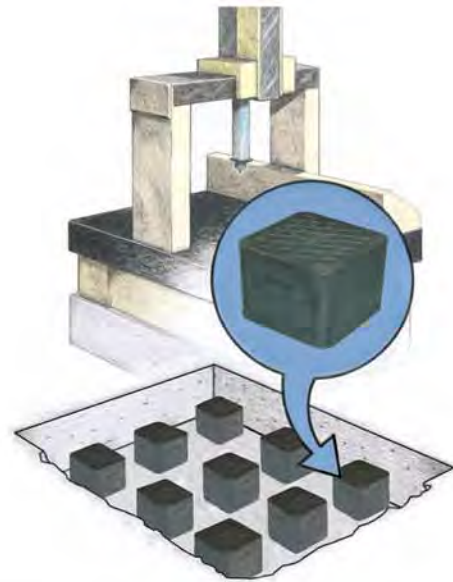

**UNISORB REGUFOAM™**

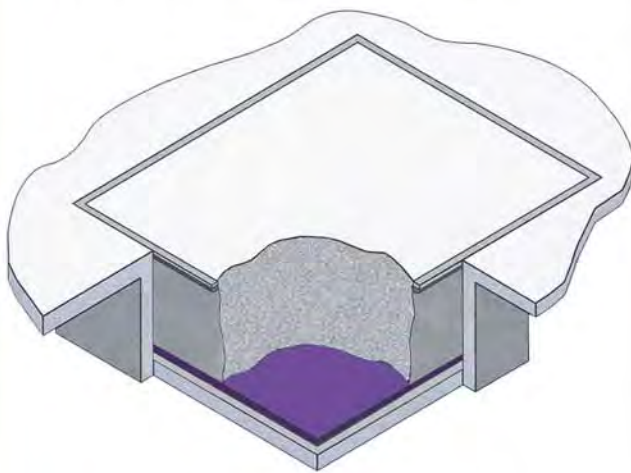

**UNISORB RD SYSTEM™**

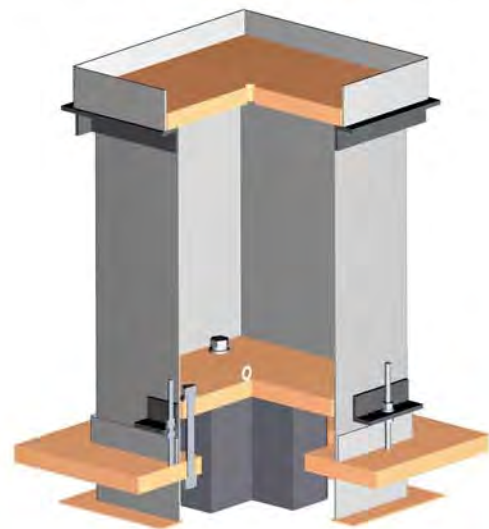

---

# INTRODUCTION AND TABLE OF CONTENTS

---

## INTRODUCTION

This UNISORB Foundation Isolation Solutions publication presents conceptual and detailed information covering the various product lines available for satisfying the needs of our customers in this important facet of equipment installation. Included is a section dealing with the subject of vibration theory. This is presented to assist in understanding the underlying reasons for the necessity of adequately isolating machinery from vibrations which adversely affect the proper performance of expensive and sophisticated equipment in their facilities. It will also aid our customers in their efforts to appropriately request UNISORB's help with their specific applications.

UNISORB's foundation isolation products have been carefully developed to provide optimum performance, even in the toughest applications and the most demanding of circumstances.

All of UNISORB's foundation isolation solutions are static/passive in nature, not requiring special construction considerations, air supply or peripheral access trenches.

Our foundation isolation solutions allow us to efficiently protect our customer's machinery by providing machine/foundation natural frequencies from 1.5 to 19 Hz.

The UNISORB engineering staff and field representatives are available to provide on-site assistance with your projects to assure that maximum product performance is attained.

UNISORB offers complete professional design/engineering services, including the development, planning and preparation of construction drawings. We will also review customer drawings to assist with the installation planning process while confirming proper applications for UNISORB products. The drawing reviews are conducted at no charge, and are done most effectively during the planning stage of a project.

UNISORB® is a registered trade name of UNISORB Installation Technologies.

## Page

## TABLE OF CONTENTS

1. The World of Unisorb
2. The Support Critical vs. Non-Support Critical Issue
- 2.-3. Common Features of the Support Critical Machine
3. Factors to Consider in Deciding Whether to Isolate
- 3.-4.-5. Vibration Theory
5. Choosing the Right Foundation Isolation System
- 6.-7.-8 IB-500 Foundation Isolation System
- 8.-9. Unisorb Regufoam Isolation Materials
- 9.-10. Unisorb GK Block System
- 10.-11. Unisorb Spring Isolator Systems
- 12.-13. Unisorb RD Foundation Insert System
- 13.-14. Professional Engineering Services
15. Case History - CMM Foundation
- 16.-17. Case History - Foundation Isolation System



INSTALLATION TECHNOLOGIES

[www.unisorb.com](http://www.unisorb.com)

BOX 1000, JACKSON, MI 49204-1000

888-4-UNISORB • 517-764-6060

ISO-9001 Certified



# THE WORLD OF UNISORB

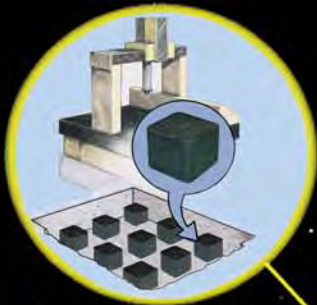

*Foundation Isolation Systems*



*Horizontal Boring Mill*



*Press*



*Medical Equipment*



*Professional Engineering Services*



*Injection Molding Machine*



*Advanced Grouting Techniques*



*General Purpose Mounting*



*Turbine Generator*

**ADVANCING MACHINERY  
INSTALLATION TECHNOLOGY**

For design assistance Contact UNISORB engineering at 888-4-UNISORB (888-486-4767), 517-764-6060, or e-mail us at [unisorb@unisorb.com](mailto:unisorb@unisorb.com). Also, please visit our web site at [www.unisorb.com](http://www.unisorb.com).



## THE SUPPORT CRITICAL VS. NON-SUPPORT CRITICAL ISSUE

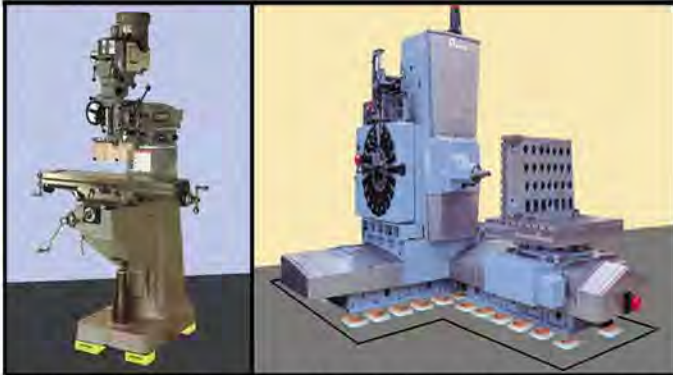

**Consider a full range of machinery, from a simple knee mill to a complex multi-component mill.**

The first question to be answered regarding whether a foundation is needed for a particular installation is if a machine is support critical or not.

Consider a broad spectrum of machines (in this case machine tools, although the analysis may be applied to any type of equipment). Now think about how they might be classified as to whether or not they require external support to perform to their design levels.

The simple milling machine (shown above left) is a good example of the non-support critical machine. Its structure is such that all operationally generated forces are resolved completely within its own structure. The "C" shaped frame, consisting of a combination of the main base and work table, exhibits a high degree of stiffness relative to the forces generated. No additional support is needed to maintain basic machine geometry during operation. This machine is therefore non-support critical.

Conversely the horizontal spindle machining center (shown above right) is a good example of a machine that does depend on external support to maintain critical cutter to work piece relationships. This machine is support critical.

Think about the classical free body analysis done in solving an engineering problem in statics or dynamics wherein all forces applied to an object are analyzed and resolved into components. The ability of the structure of the machine being installed must be evaluated with regard to its ability to resist those forces and an installation approach selected that supplements the machine's own design in such a way as to maximize machine performance.

The illustrations that follow depict cutaway views of two of the Unisorb products designed to satisfy the needs of the non-support critical and support critical machines. Notice that the Level-Rite Mount provides isolation as well as leveling capability, while the Fixator System provides rigid anchoring/alignment required for precision machines which are support critical. Foundation isolation material

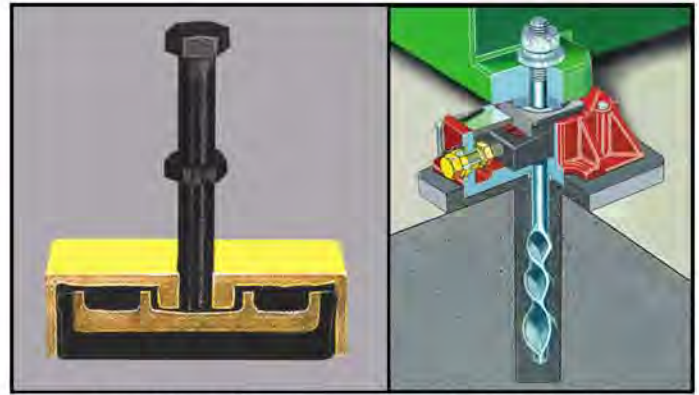

**Level-Rite Mount  
(Free-Standing)**

**Fixator System  
(Anchored)**

applied to the exterior of the foundation provides vibration isolation if needed.

It can be generally said that non-support critical machines can be isolated on free standing mounts.

## COMMON FEATURES OF THE SUPPORT CRITICAL MACHINE

- Presence of an OEM supplied anchor system and stated requirements for a minimum foundation
- The requirement for in-place alignment
- Elimination of use of free-standing mounts
- Design consisting of unconnected segments
- A machine which cannot be made structurally rigid enough economically due to its configuration or size

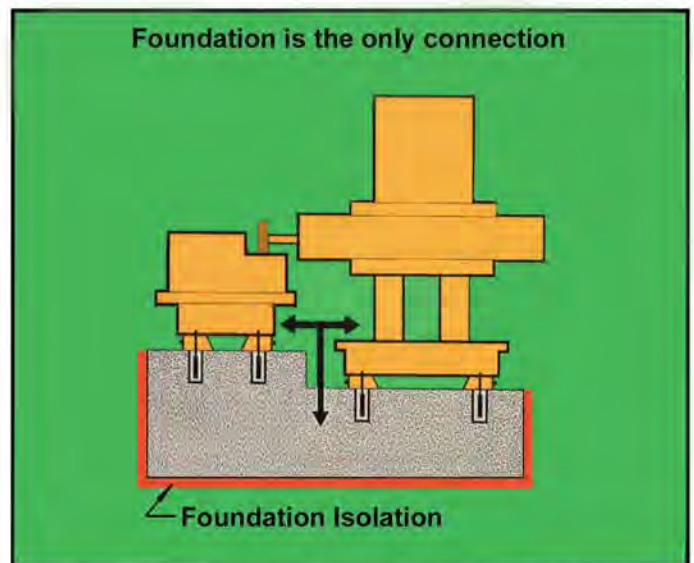

**Typical support critical application where the foundation holds the machine tool components in alignment.**



A very important clue in determining if a machine is support critical is the presence of a factory designed or specified anchoring system. In the cost conscious world of the machine manufacturer, an anchoring system is only provided or recommended if it is truly necessary to achieve design performance levels. This is not an absolute statement, but it is accurate most of the time.

Once the requirement for an anchoring/alignment system has been established, the next step is to decide on the best approach, and of providing an adequate foundation.

Exceptions:

It should also be noted at this time that there are situations where the natural frequency of the required isolation system will be lower than those levels attainable with free-standing mounts. In these situations an isolated foundation may still be required for a non-support critical machine solely for the purpose of providing adequate isolation. The relationship of natural frequency and isolation will be discussed later, in the section on vibration theory.

---

## FACTORS TO CONSIDER IN DECIDING WHETHER TO ISOLATE

---

- High traffic (external or internal)
- Nearby presses or mills taking heavy interrupted cuts
- To avoid disturbing the surrounding environment with energy from machine being installed
- Interference from nearby rail lines

It is always a good idea to have a vibration survey done to determine actual vibratory energy levels in the area where the machine is to be located. The next considerations are the specific machine requirements. This would include reviewing any OEM specifications related to vibration acceptable at the equipment under operating conditions.

It may be necessary to examine the soil conditions, which may vary greatly from stiff clay to very soft high organic content top soils with a high water table.

Future facility considerations also need to be taken into account, such as expansion and moving plans. If dealing with a new facility, be sure to make good use of historical data. Unisorb's experience in this area is unequalled.

The primary difference between approaches available for isolating the foundation is the characteristic natural frequency range attainable. As will be seen in the next section, it is extremely important to know what disturbing frequencies need to be isolated.

## Vibration Sources

Shown in the illustration below are some of the typical sources of disturbing vibrations. Each of these sources will exhibit a different amplitude/frequency characteristic. Shown are railroads, truck traffic, fork trucks and metal stamping equipment.



These sources can adversely affect the machine to be isolated or may simply contribute energy to excite other system elements (i.e., the building structure and floor) to vibrate at their own natural frequencies, thus causing machine accuracy and maintenance problems.

Each facility has its own individual machine location layout. When developing an isolation scheme, it will be necessary to decide whether it is more advantageous to isolate the source of a shock/vibration condition, or the sensitive equipment which is vulnerable to the disturbances.

In the typical industrial environment, it would be normal to see building and plant floor natural frequencies starting as low as 18 to 24 Hz, and transmission from railroads, presses and highways occurring at even lower natural frequencies.

---

## VIBRATION THEORY

---

The fundamental requirement for designing a functioning foundation isolation system is to establish the proper relationship between the forcing frequency and the natural frequency of the isolation system. In most cases our objective is to assure that the natural frequency is lower than the forcing frequency. Please refer to the Transmis-



sibility Chart shown below. This is the classical transmissibility curve which shows the relationship between forcing frequency, natural frequency, and the transference of mechanical energy by the vibration isolation system being analyzed.

Note there are three separate curves, one for each of three levels of damping. The damping coefficient refers to the rate at which the system absorbs energy. The higher the coefficient of damping the more energy is consumed in the operation of the system. The damping coefficient is determined by the performance characteristics of the isolation material.

Let's assume that the system we are dealing with is a simple mass/spring system with only one degree of freedom. The foundation/machine/isolator system can be represented by a mass (the machine and foundation) supported by a deflectable element (the isolation system), with a parallel damping element.

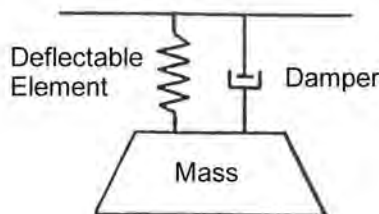

The variables represented are as follows.

**Transmissibility:** A non-dimensional ratio of the amplitude of the response of an isolation system in steady state forced vibration to the input of that system.

**Natural Frequency:** The rate at which the system would naturally vibrate expressed in Hz (Hertz) if set into motion and allowed to continue in motion without outside interference. The primary factor determining the natural frequency of any isolation system is the load/deflection characteristic (or spring rate) of the deflectable element chosen for the isolator. The value for the natural frequency of the illustrated system is given by:  $\frac{1}{2\pi} \sqrt{\frac{k}{m}}$

**Forcing Frequency:** The frequency (Hz) at which an externally applied excitation or "disturbance" is applied. The forcing frequency is also sometimes referred to as the "disturbing frequency".

**Forcing to Natural Frequency Ratio:** The product of an externally applied excitation (Forcing Frequency in Hz), divided by the system's natural frequency in Hz.

**Resonance:** A condition where the natural frequency of the isolation system and the forcing frequency match. This causes a resonant condition which is very detrimental to the operation of a machine (or many machines).

A TYPICAL EXAMPLE USING A 3:1 RATIO WITH A 10% COEFFICIENT OF DAMPING YIELDS A SYSTEM EFFICIENCY OF 85% (15% TRANSMISSIBILITY)

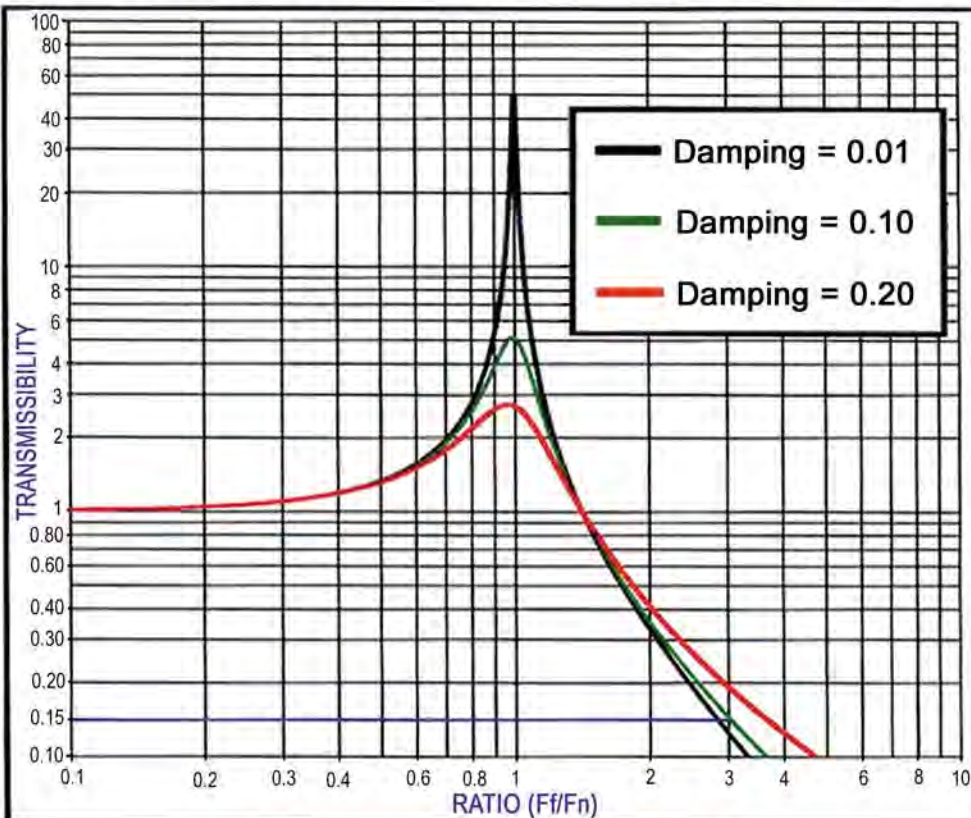

TRANSMISSIBILITY CHART

Note that at the left side of the chart the curve intersects the vertical axis at a value of 1. This indicates that for very low forcing to natural frequency ratios the amplitude of the mechanical input to the system is equal to the output from the system. As the forcing frequency to natural frequency becomes larger, the transmissibility becomes greater, in that the output of the system is larger than the input. More simply put, the system is amplifying the input. This condition reaches its maximum when the forcing frequency ratio reaches 1:1. At this point the system is said to be in "resonance", and its output is theoretically infinite. In the real world energy is consumed by the system components and the actual amplification seen is limited.



Moving our focus back to the basic curve, you will note that for forcing to natural frequency ratios greater than 1, the transmissibility falls rapidly back to the 1.0 value when the  $Ff/Fn$  ratio reaches 1.414 ( $\sqrt{2}$ ), and becomes less than 1 for all values greater than this. Note that for transmissibility values falling above the "1.0" line the system will actually amplify the disturbing frequency. The region of isolation or energy reduction begins at the point that the curves cross the "1.0" line (which is 1.414 times greater than the resonance of the system).

Our target for proper system design is to establish a forcing to natural frequency ratio that falls as far as possible to the right of this point on the curve. Note that for a typical system having a forcing to natural frequency ratio of 3.2:1 we can read a transmissibility value of .15 using the black (.01 coefficient of damping) curve. With a transmissibility of .15 it can be said that the system is isolating 85% of the applied vibration.

As noted above, this explanation considers a system with only one degree of freedom, and a single natural frequency. In practice this analysis is completed for all 6 degrees of freedom, at each natural frequency present in the isolation system, and for each forcing frequency occurring in the actual environment.

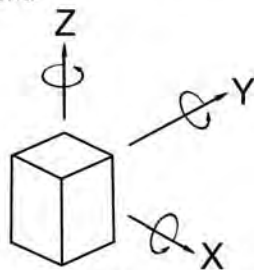

**Six degrees of freedom**

A complete analysis requires the use of sophisticated computer modeling techniques. When transient shocks are added to the mix the analysis becomes even more complicated. Unisorb's vast experience in this field puts us in a position to offer unparalleled design assistance even in the most difficult applications.



## CHOOSING THE RIGHT FOUNDATION ISOLATION SYSTEM

- **IB-500**



**8 to 19 Hz**

- **Regufoam**



**6 to 15 Hz**

- **GK Blocks**



**3 to 6 Hz**

- **Spring Isolator Systems**



**1.5 to 6 Hz**

Having seen the significance of system natural frequency with regard to overall performance, we can now look at typical system natural frequencies for various Unisorb foundation isolation systems. Unisorb offers solutions that can produce system natural frequencies as low as 1.5 Hz.

We will present four methods, along with a typical natural frequency range for each. Once again, the need for a competent and professional vibration survey cannot be stressed enough. This is important because it will identify the actual conditions present at the installation site. This will allow Unisorb engineers to choose the proper method of isolation.

It is also extremely important to review the manufacturer's specified vibration limits and recommendations for the particular machine being installed. The available data range from extremely detailed OEM issued specifications to very general and non specific data, depending on the machine manufacturer involved. Unisorb's experience in this field can be of great value in interpreting these data and developing appropriate criteria for a particular installation.



# IB-500 FOUNDATION ISOLATION SYSTEM

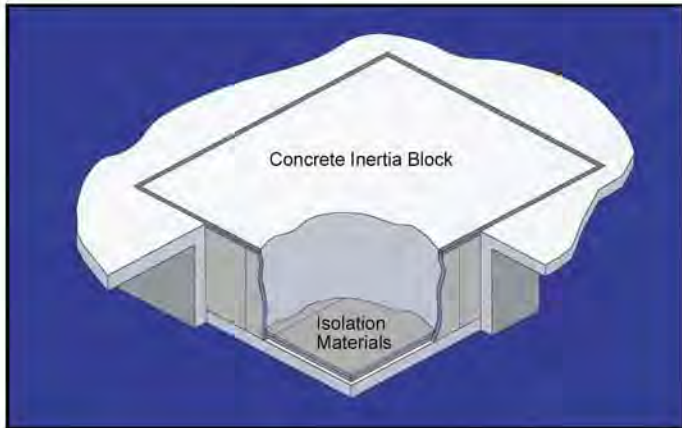

The Unisorb IB-500 system is the simplest to install of all approaches. With a natural frequency in the 8 to 19 Hz range, the IB-500 system is capable of serving the majority of industrial applications very well. It consists of a concrete inertia block sized to provide adequate support for the machine being installed. It also supplies sufficient mass to give needed damping to the system being supported by Unisorb's IB-500 series foundation isolation pad materials, supplied in sheets 1/2" thick. Unisorb will help with the final design of this system to assure that maximum performance is achieved.

There are basically three construction methods to choose from when installing Unisorb IB-500 materials. The following descriptions and illustrations will address these in detail.

- **Materials placed in Excavated Pit**
- **Casting a Concrete Lined Pit in which to place isolation materials**
- **Oversize Excavation which allows sidewall backfill**

## Excavated Pit

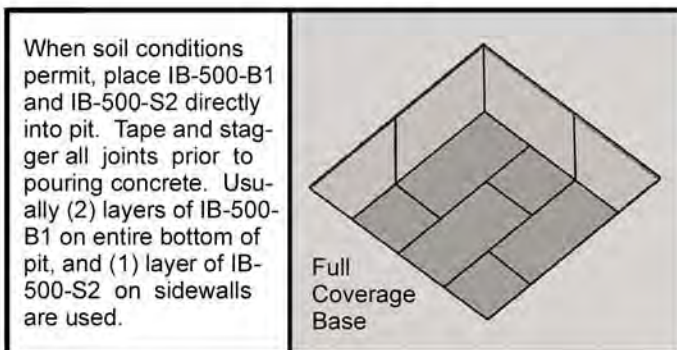

IB-500 foundation isolation pad materials are suitable for direct exposure to wet concrete, however the joints must be sealed with Unisorb IB-500 Seam Tape to prevent the incursion of fluid concrete during pour. It is also advisable to place a Unisorb Poly Pit Liner inside the lined pit to assure that no "short circuits" occur.

In some cases it is necessary to provide "Partial Coverage" on the base of a foundation due to a need to achieve a higher pad loading and resultant lower natural frequency than is possible with full coverage. The following illustration depicts this.

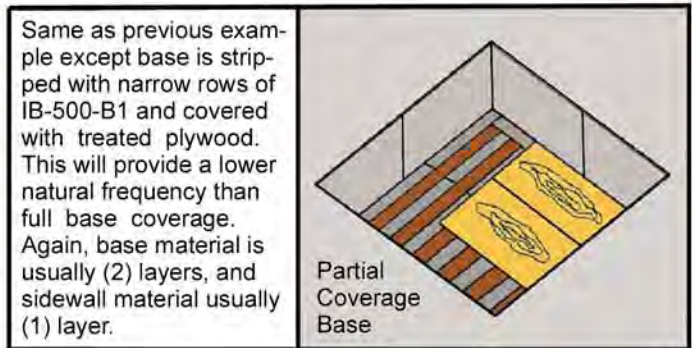

A mud mat is poured, then rows of base isolation material are placed, with the air gap integrity protected by sheets of treated plywood. This allows more weight to be concentrated on the base material, thus driving the pad loading up and the natural frequency down.

Sometimes it becomes necessary to use more than (2) layers of base and (1) layer of sidewall material. This is true for either full or partial coverage designs. This is done to fine tune the natural frequency of the foundation to suit the needs of the specific installation.

Following are some photos taken of an actual excavated pit installation.



Note the exposed soil of the sidewall in this photo. Soil conditions at this location permitted a straight, smooth sidewall to be dug with minimal effort. Also note that the sidewall materials are taped to the concrete floor surface to hold them in place.





Here a mud mat is poured, then IB-500-B1 base material is applied in strips to achieve the desired pad loadings. In the foreground a sheet of treated plywood is being installed to protect the integrity of the spaces between the strips of base material (to prevent fluid concrete from entering the spaces). Notice that there is a strip of IB-500-B1 material around the perimeter of the base of the foundation as well as across (the full length).

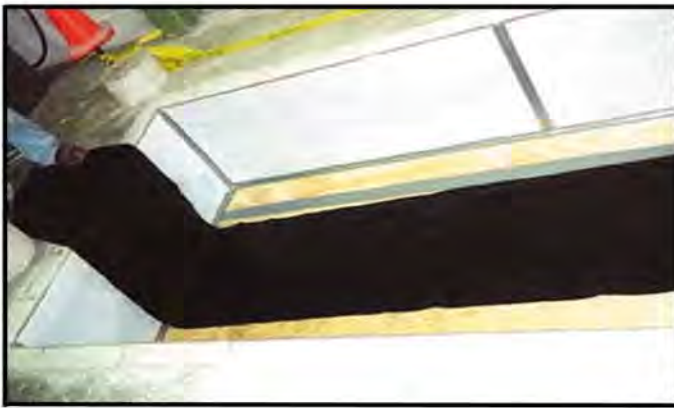

In this photo a Unisorb Poly Pit Liner is being installed over the treated plywood sheeting.



Here we have another view of the same foundation ready for the placement of the reinforcing steel and concrete.

### Concrete Lined Pit

When soil conditions require, or when using partial coverage base, form and cast in place a concrete lined pit. Place IB-500 materials inside, using either full or partial coverage as addressed in previous illustrations.

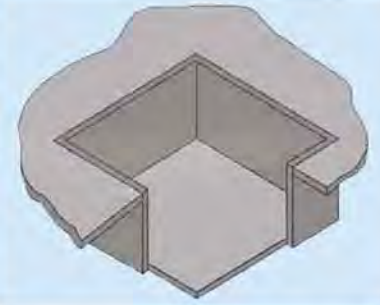

This method of construction is used where soil conditions are less than ideal, or when it is desirable to provide a positive seal against contaminants reaching the sub soil. This creates a "socket" for the isolation material and inertia block foundation to be placed.

**Following is a photograph showing a Concrete Lined Pit type foundation taken on an actual job site.**



In this instance a concrete lined pit has been prepared due to less than ideal soil conditions. Note the "stepped" construction to establish the desired machine height.

### Oversize Excavation

After pouring foundation in oversize pit, apply IB-500-S2 to sidewalls and backfill. Compact soil and complete concrete work to joint.

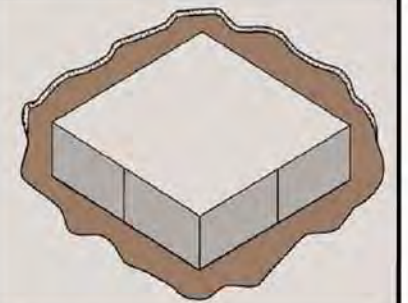

The third acceptable method for installing Unisorb IB-500 materials is to dig an oversize pit. Here the foundation is poured directly on the IB-500-B1 base isolation material using removable forms to contain the perimeter. Once sufficiently cured, the sidewall forms are removed, and the isolation material is applied to the sidewalls. The pit is then backfilled directly against the IB-500-S2 sidewall material. This method is very cost effective when sufficient clearance is available to permit the larger excavation.



### **Prior to Pouring Concrete Checklist (All three methods)**

- **All seams to be taped with Unisorb IB-500 Seam Tape.**
- **Do not puncture or bridge IB-500 pad materials with fasteners of any type.**
- **Install Unisorb Poly Pit Liner after the IB-500 materials are in place.**
- **Support re-bar with load spreading chairs or blocking materials.**

### **Floor Level Joint Treatment**

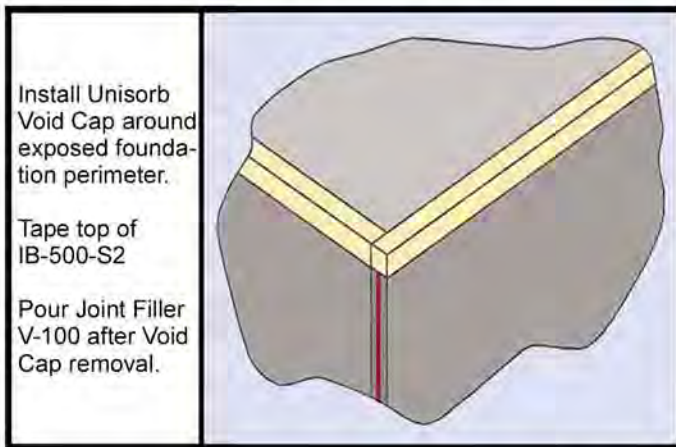

In all installations a sealed joint at floor level is desired. The sidewall material is placed 1/2" below the surface of the concrete, and a Unisorb Void Cap strip is inserted to create a preformed space for the application of Unisorb Joint Filler V-100 material. This material comes in a two part kit, and is simply mixed at the job site and poured into the channel created by the removal of the Void Cap strip after the concrete has sufficiently cured. The Joint Filler V-100 material is highly resilient, and colored gray to match the surrounding concrete.

### **IB-500 Pad Material Availability (All three methods)**

The IB-500 pad materials are supplied in 36" x 72" sheets to be cut to fit on the job site. In the case of partial coverage base type designs, 6" or 12" wide x 72" long strips of IB-500 base material may be supplied.

Unisorb's IB-500 isolation pads have been tried and proven in thousands of applications worldwide, and passed the test of both time and performance with flying colors. Consult with our Engineers about your application.

## **UNISORB REGUFOAM ISOLATION SYSTEMS**

For installations requiring lower system natural frequencies (in the 6 to 15 Hz range) the IB-500 series can be replaced with Unisorb Regufoam Isolation materials.



These materials are extremely long life polyurethane foams which are well proven in isolated foundation applications. These highly sophisticated engineered materials provide very predictable performance, and are very resistant to contaminants found in the industrial environment.

Unisorb engineering will assist with the application of these pads to assure maximum performance.

- **Natural Frequency Range of 6 to 15 Hz**
- **Proven long life**
- **Simple installation**
- **Ideal for installations that require shallow concrete foundations or steel plates**

Regufoam is applied as a vibration isolating structural element in the installation of both source and sensitive equipment. Regufoam installations provide a cost effective and simple approach to preventing the transmission of structure borne noise and vibration. Regufoam is an engineered combination closed and open cell foam material that exhibits excellent vibration isolation characteristics. It has exceptional damping and superior durability in the industrial/commercial environments as proven in over two decades of successful applications.

The illustration on the following page shows a machine mounted on a steel plate with Regufoam isolation material underneath. Other applications include inertia blocks, pump service pad isolation, and air handling equipment service pad isolation.





When used under a poured concrete foundation or slab, Unisorb recommends covering the Regufoam base pad materials with 3/4" thick construction grade industrial treated plywood. This will maintain the integrity of the flat bearing surface on the Regufoam pad material. An air gap is preferred around the perimeter of the sidewalls of the foundation. This is because we do not want the lower natural frequencies which are made possible by the use of the Regufoam base pad materials to be altered by the presence of any sidewall pad materials.

## UNISORB GK BLOCK SYSTEM

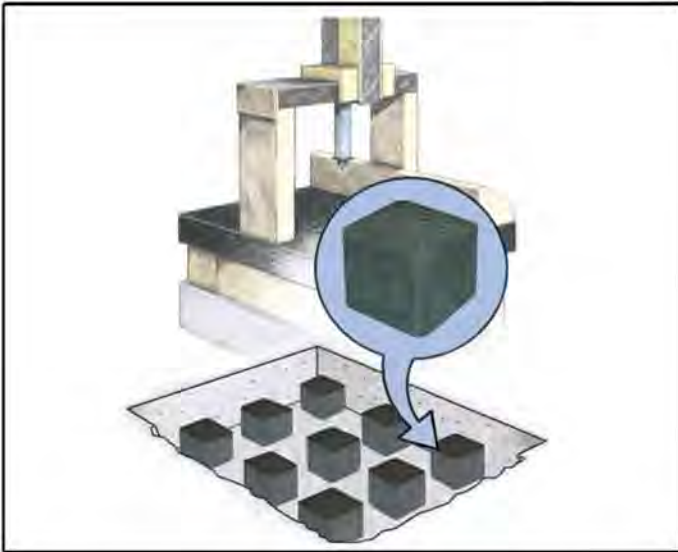

The fundamental design requirement for the Unisorb GK Block System is that the inertia or foundation block be installed free-standing on the isolation blocks with no other contact with its surroundings.

The GK Block System provides system natural frequencies in the 3 to 6 Hz range and is highly effective in isolating both source and sensitive machines.

The GK Block System is frequently the first choice in isolating highly sophisticated coordinate measuring machines and other equipment requiring low natural frequencies.

There are three construction methods recommended for installing Unisorb GK Blocks. The following descriptions and illustrations will describe these in detail.

- **Pre-Cast Design**
- **Box Design**
- **Plywood & Re-Bar Design**

### Pre-Cast Design Procedures

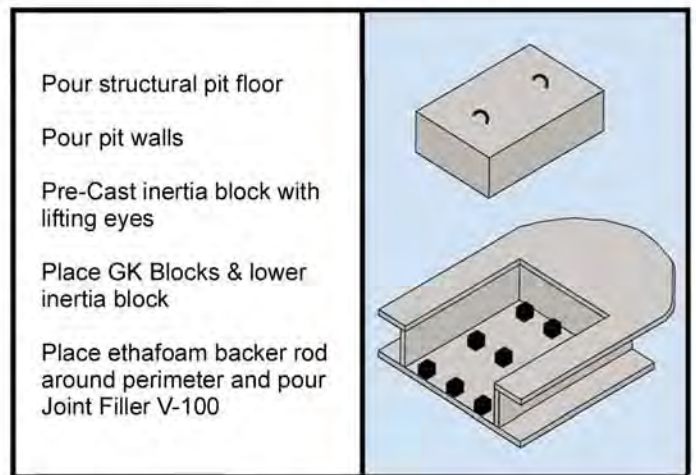

The Pre-Cast system works well when the foundation being installed is within the range of available lifting equipment. This technique is very cost effective, and has the advantage of providing a foundation that is literally portable. This design also permits the design of a "reusable" foundation that can outlive several machine installations.

### Box Design Procedures

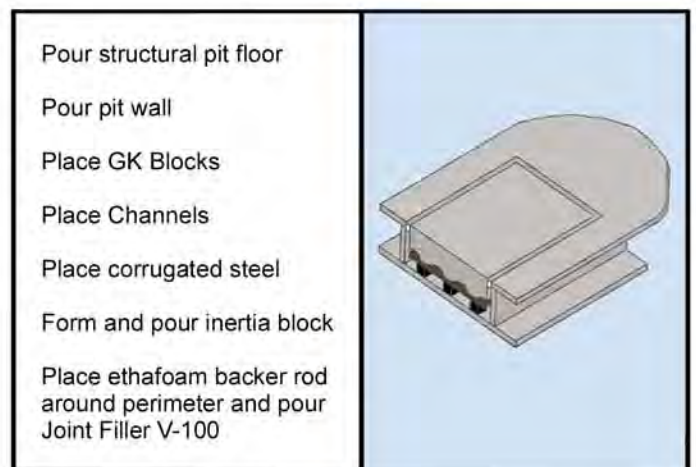



## Box Design Procedures (Cont.)

With this approach the GK Blocks are placed in a prepared pit, forms are constructed, and concrete is poured. A corrugated steel bottom plate is frequently used to provide a cost effective way of forming the inertia block. The creation of an air gap around the perimeter of the foundation assures that the system functions at maximum efficiency.

## Plywood & Re-bar Design Procedures

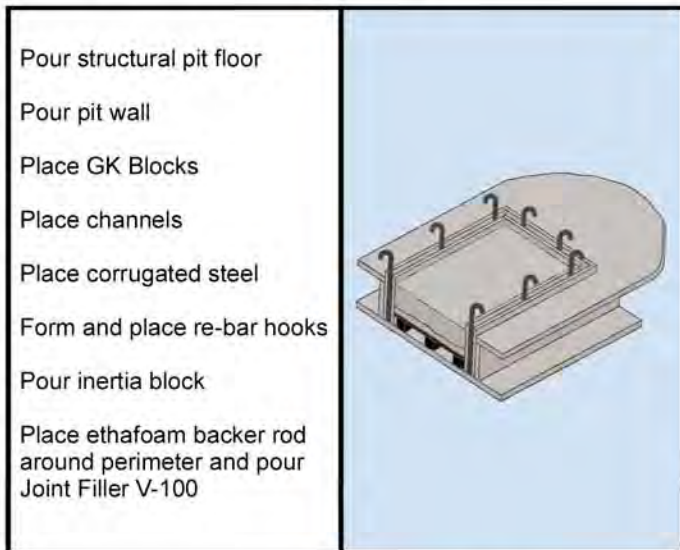

Special design procedures are followed to facilitate form removal after concrete curing is complete. This approach is often used for larger foundations. After the concrete is sufficiently cured the re-bars which have been installed to hold the plywood side forms in position are removed permitting the sidewall forms to be easily stripped. This method permits a small sidewall air gap to be maintained. Once the sidewall forms have been removed, an ethafoam barrier is placed into the sidewall air gap and positioned in such a way as to provide a channel for Unisorb Joint Filler V-100 to be poured to create a seal at the top.



Typical large GK Block foundation under construction. Notice that the workmen are placing the plywood decking that in this case will support the concrete foundation.

## UNISORB SPRING ISOLATOR SYSTEMS

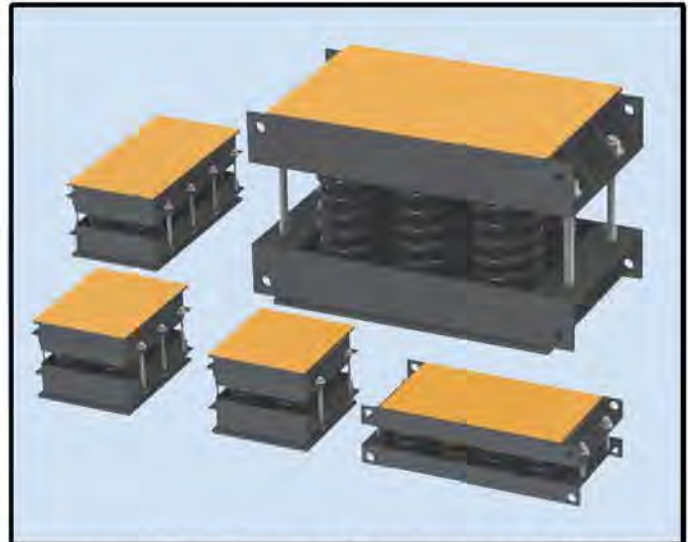

### UNISORB ST Heavy Duty Spring Isolators

- For use with precision machinery, power generation, medical, CMM, Test Equipment and other applications.
- Available in 1.5 Hz to 6 Hz Natural Frequency.
- Shipped compressed and ready to install.
- Durable housings with Powder Coat finish for long life.
- Springs are powder coated for long life.
- Available with adjustable leveling and snubbing.
- High frequency attenuation standard on all models.
- Additional damping option available.

UNISORB has designed the ST series of spring isolators to provide superior isolation performance with vertical natural frequencies as low as 1.5 Hz. The ST isolators are appropriate for use in a wide variety of applications found in industrial and medical environments.

### Common applications include:

- Roll Grinders
- Gear Grinders
- Precision Mills and Machining Centers
- Coordinate Measuring Machines (CMM)
- Magnetic Resonance Imaging (MRI) equipment
- Stamping Presses
- Gas Turbine Generators
- Dynamometers
- Road Simulators
- Earthquake Simulators





Spring Isolators are typically used to support and isolate concrete foundations of all sizes. The mass of the foundation provides most of the needed damping while the stiffness of the foundation provides the support to maintain the alignment of the machine being installed thereon. UNISORB can assist with the design of the concrete foundation with our Professional Engineering Services such as preparing civil engineering construction documents and performing a Finite Element Analysis. These services are provided on a "for fee" basis.

Each ST series isolator consists of a welded steel housing, a series of specifically prescribed precision steel compression springs and adjustment hardware, along with top and bottom bearing pads.

The steel coils are manufactured from high quality steels like those used in high endurance spring applications. Each spring coil is designed to provide the sort of large deflections needed to develop low natural frequencies. The springs are finished by grinding and peening the ends to toughen them against premature breakage.

The housings are fabricated from standard steel shapes and sections. After welding and machining, the housings are powder coated to ensure a long installation life. ST spring isolator housings are designed for the high stress demands of low natural frequency isolation systems. The springs are also powder coated.

The UNISORB ST series spring isolators are assembled with retaining bolts so that the isolators are pre-stressed to facilitate easy installation. Foundations isolated with spring type isolators typically need to be lifted to permit the placement of the isolators under the foundation. Then the foundation must be slowly lowered into position until the springs have completely deflected. Pre-stressing of UNISORB ST Spring Isolators reduces the distance the foundation must be lifted and then lowered before the isolators are properly loaded. Once in position, the retaining bolts hang loosely so as not to affect the final performance of the isolation system.

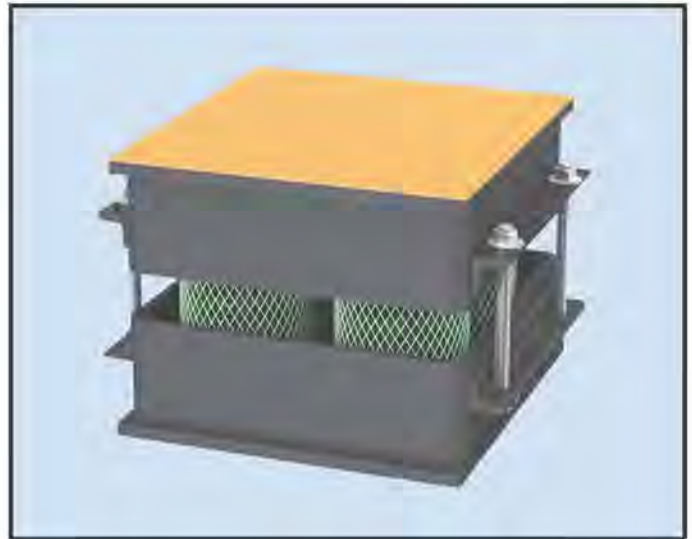

UNISORB's engineering staff can design custom modifications that may be needed for a given application. Such modifications may include adjustment mechanisms for load balancing, damping pots to add damping to the system, and unique spring designs to achieve the specific project requirements.



Contact UNISORB at 517-764-6060 for more information regarding custom designed spring isolator solutions.



# UNISORB RD FOUNDATION INSERT SYSTEM

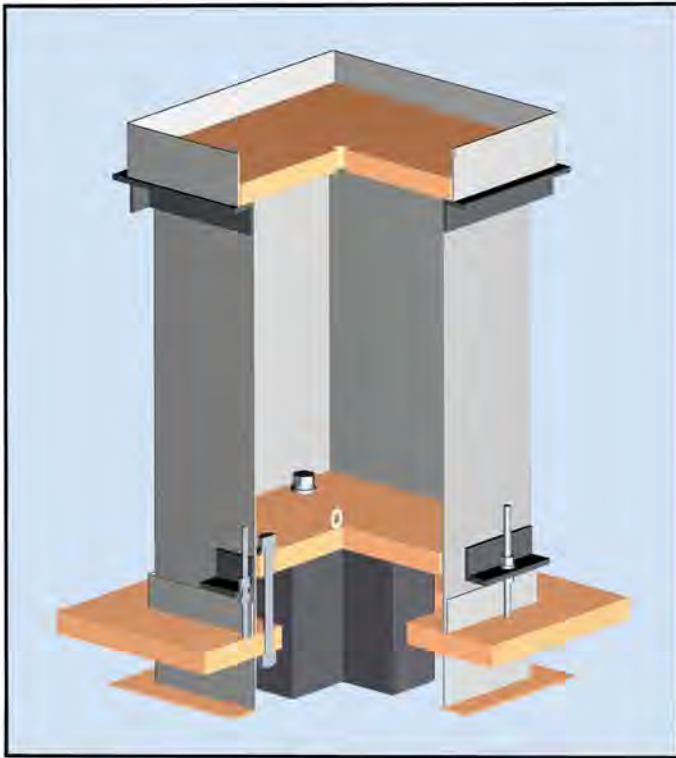

The system consists of a foundation insert package that is cast into the inertia block foundation. Each insert is equipped to accept a wide variety of isolation materials or devices ranging from simple pad materials, Unisorb GK Blocks, or Unisorb Spring Systems.

This uniquely designed system is capable of producing system natural frequencies as low as 1.5 Hz, and is very effective for the most sensitive machines, laboratory floors, and other applications where extreme isolation levels are required. The RD System is equally effective when applied under vibration source machines, such as shakers.

The RD System allows the foundation to be poured flat while using the pit liner or "mud mat" as the base form, thus greatly simplifying construction.

Once the inertia block foundation has cured sufficiently, the isolators are inserted into the RD units, and the RD System is adjusted to raise the foundation into operating position.

**Primary features of the RD Foundation Insert System include the following:**

- **Finished foundation may be leveled and height adjusted after construction**
- **Horizontal and vertical stiffness may be tailored to the specific application**

- **Individual isolator units may be easily serviced or replaced, utilizing the RD Unit to access the isolator from the top**
- **Foundations may be reused by simply changing the isolator units to suit the new application**

The RD Foundation Insert System is very well suited for use in medical or clean room environments, as well as in general industrial areas, because the need for providing below grade manways for perimeter access is eliminated.

## ***RD System Installation Procedures***



Here we are beginning the installation of a typical RD unit foundation. Plywood forms are used (supplied by Unisorb) to act as a template for the location of the individual RD units, and to provide a smooth surface on which to seal the concrete forms. This plywood is secured to the foundation block, and is lifted clear of the sub-slab when the foundation is raised into operating position. The RD Anchor Rings are then placed into the openings in the plywood.



The joints between the plywood base form sheets are being sealed with Unisorb Premium Grade IB-500 Seam Tape and fasteners are being installed to extend into the concrete to assure that the form is lifted with the foundation. Splice boards are then attached to the plywood base form sheets to provide sure continuity between them.





The adjustable height upper tubes are being installed. The finished upper level of the foundation is at the top of the RD unit.

Note that all of the RD unit components are small enough to fit through most doorways, and can be positioned without the use of lifting equipment.

Upper tube heights are adjusted by the bolts on three sides of the RD unit flanges.



On the left the alignment process is shown as the RD units are brought into final position before the placement of reinforcing bars and the concrete pour.

Note that the plywood top plates are temporary. Steel, fiberglass or aluminum finish top plates will be used as dictated by each individual application according to the customer's wishes.

The right view shows a finished foundation with only the top plates being visible. This particular foundation is about 0.6 meters thick and weighs in excess of 50 tons.

In the photo on the right the machine has been placed into the room, and the installation is nearly complete. The floor has been leveled using the RD units, and a vibration analysis is being conducted under full load conditions.



The RD unit is supplied with all necessary materials (including forms, hardware, and pre-fabricated re-bar if desired) and is easily installed by any contractor familiar with basic concrete construction techniques.



*Expand your project team with UNISORB'S proven expertise.*

- Industry's most experienced staff in machinery installation design
- Worldwide experience in all types of equipment
- Services ranging from conceptual design assistance to full turnkey project management
- Proven track record of innovative solutions to a wide range of installation problems
- Proven cost effective on both large and small projects

UNISORB'S engineering staff, the most experienced in the industry, can provide services ranging from conceptual design to complete construction ready packages including construction management and inspection services. Whether providing a simple design review or a complete turnkey package, our staff is uniquely qualified to identify the critical elements of your project, and assure that they receive the attention they deserve. Our decades of experience creating cost effective, successful installations is at your disposal in producing a quality installation which will impact your machine's performance throughout its useful life.



*General design including civil/structural engineering*





*Construction documents and coordination*

UNISORB provides engineered construction documents for general contractors to use for bidding and construction. These include complete project specifications to assure that critical construction issues are identified and completely defined. Also included is a detailed list of criteria for the inspection and approval process. This documentation assures a smooth, delay free project. We will provide complete construction management, coordination of contractors, and inspection services as desired, assuring minimum project completion times.

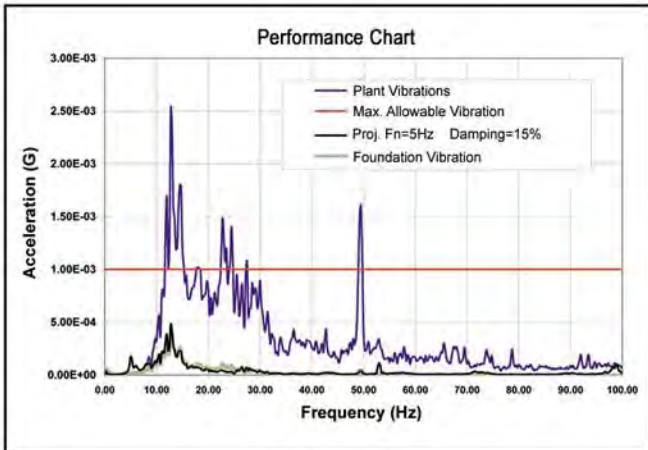

*Site qualifications*

UNISORB'S assistance with site qualifications assures that the performance of the finished installation is predictable. On site environmental vibration analysis, coupled with interpretation of basic soils and other data provides a basis for assuring that an acceptable shock and vibration environment is established without overspending or designing solutions to nonexistent problems.

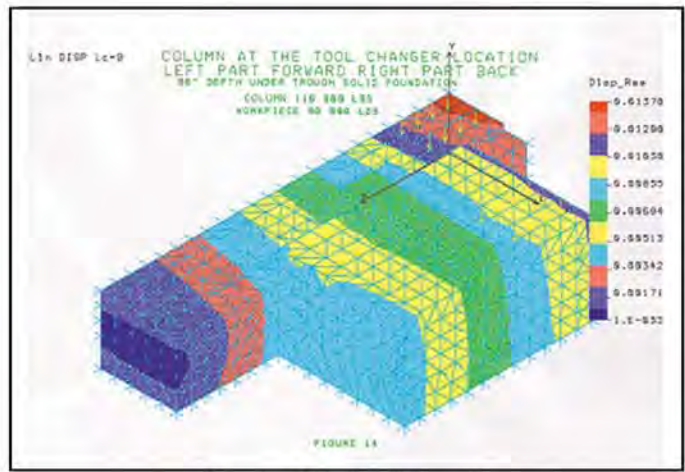

*Advanced engineering services*

For more complex and critical installations where both machine and foundation are subject to large dynamic operating forces, UNISORB can provide detailed structural analysis including computer modeling and finite element analysis. This assures that unwanted bending and twisting in either the machine or foundation doesn't produce unexpected modes of vibration which adversely affect machine performance. These services are not restricted to new installations, and are often very useful in resolving problems with existing machines.

Why choose UNISORB? Bottom line...UNISORB will help get your equipment up and running faster, better and for less cost. It's our business and we are the leader! Our daily involvement in projects like yours eliminates long learning curves and assures that performance critical issues are addressed and not left to chance. Whether our involvement is at the design review or full turnkey project level, UNISORB is your best choice. Call us now at 888-4-UNISORB to discuss your project today.



*Construction ready package*



# UNISORB CASE HISTORY CMM FOUNDATION

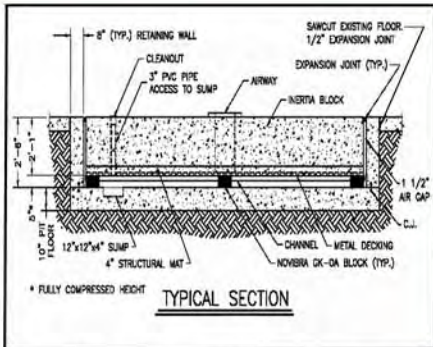

1. Foundation Cross Section



2. Concrete pit vault ready to receive UNISORB Foundation Isolation System



3. Placement of UNISORB GK Foundation Isolation Blocks

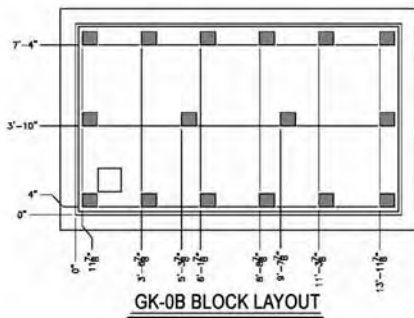

4. Layout engineered for system center of gravity



5. Setting of underlayment decking to support foundation



6. Reinforcing rebar cage

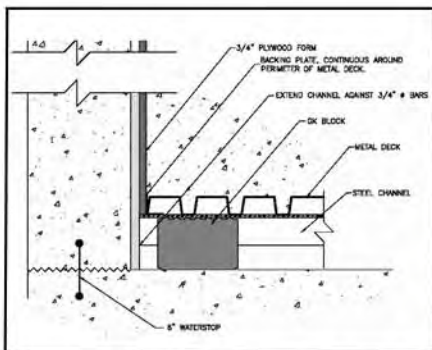

7. Foundation isolation system section



8. Inertia block concrete placed



9. Granite tile installed

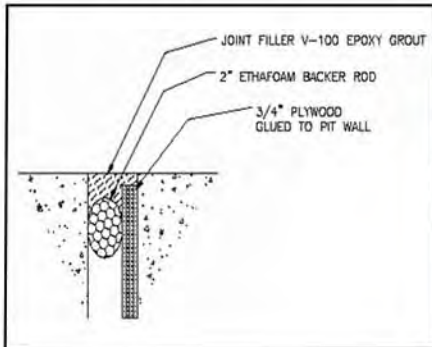

10. Detail of air gap joint



11. Application of Joint Filler V-100 Epoxy



12. Foundation Complete



# CASE HISTORY OF ISOLATED FOUNDATION (5-AXIS MACHINING CENTER INSTALLED IN A FORGE SHOP)

Vibration isolation is dependent on a number of system properties, one of the most important being the proper relationship between two frequencies (the natural frequency of the isolator and the frequency of the disturbing vibrations in the environment). The isolation system can be designed with the proper natural frequency if the disturbing frequencies are known.

Fortunately the disturbing frequencies of most facilities fall into common ranges, and the choice of the natural frequency is a simple matter. The installation of equipment that is sensitive to vibration in a facility that includes severe shock and vibration may need additional evaluation in the foundation isolation study to obtain exact information on the proposed site. In this way we can propose the most cost effective solution possible.

An example is the following case history, where the facility consisted of a machine shop adjacent to the forge shop. Unisorb was contacted to evaluate the environment when a new precision 5-axis machining center was purchased. The shock and vibration generated in the forge shop was already known to affect the manual machines in the machine shop, and now a more sensitive machine was to be installed in the same environment.

The vibrations at the proposed machine location were recorded and plotted with the allowable machine vibration limit as shown on Chart 1. The projected vibration resulting when using various isolation systems was plotted with

the site data on Chart 2. The importance of obtaining the right relationship between the two frequencies is seen in this chart. An isolation system with a 4.4 Hz natural frequency shows reduction below the machine allowable at all frequencies. An 8 Hz natural frequency also shows reduction, but not enough to be below the machine allowable. A natural frequency of 12 Hz is so close to the disturbing frequencies that they are amplified. The negative effect of the amplification that occurs at resonance is avoided by knowing the disturbing vibrations and choosing the proper isolation system.

A follow up study performed after the installation of the machining center shows the actual system performance. This is shown on Chart 3, compared to the projected performance. Note that the projected and actual vibration curves are virtually identical, indicating the success of the installation. The customer was very happy with the installation, and with the performance of the machines.

Other case histories, complete with names of companies and methods of isolation are available on request from Unisorb Engineering.

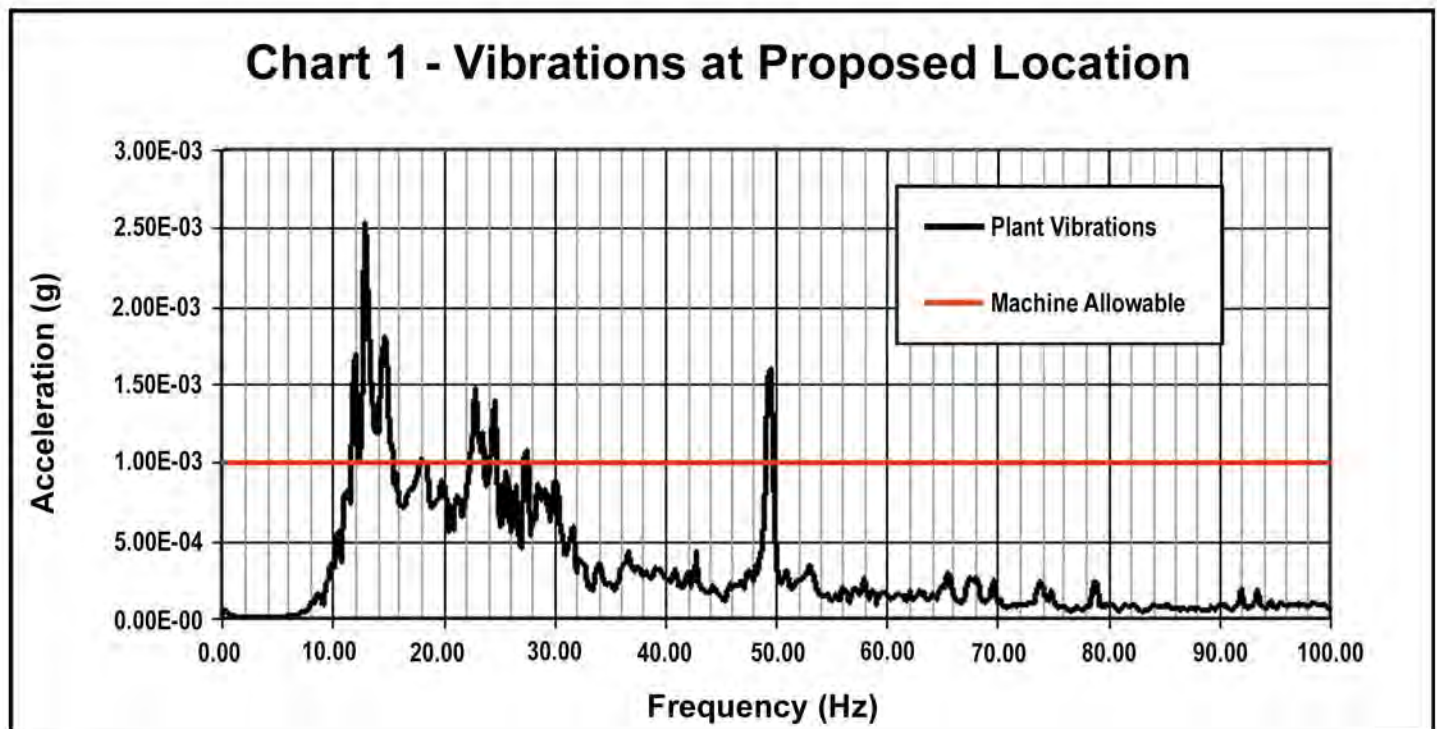



### Chart 2 - Efficiency of Various Isolation Systems

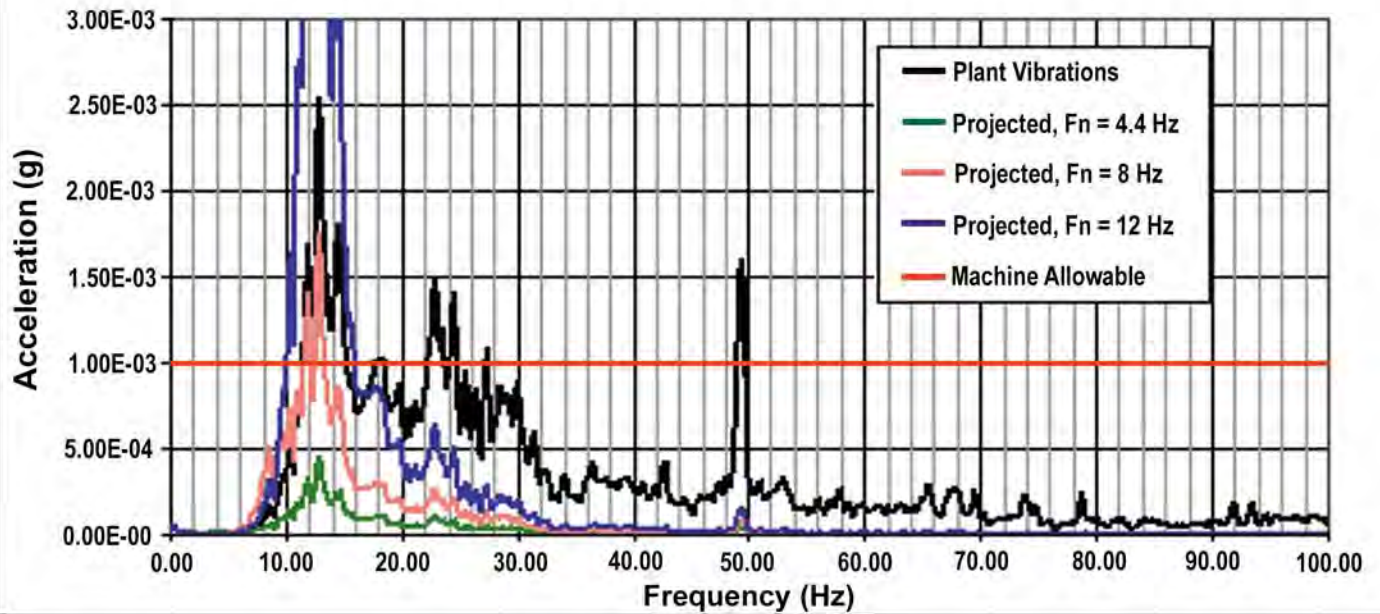

### Chart 3 - Isolation System Performance Chart (Actual Performance of Finished System)

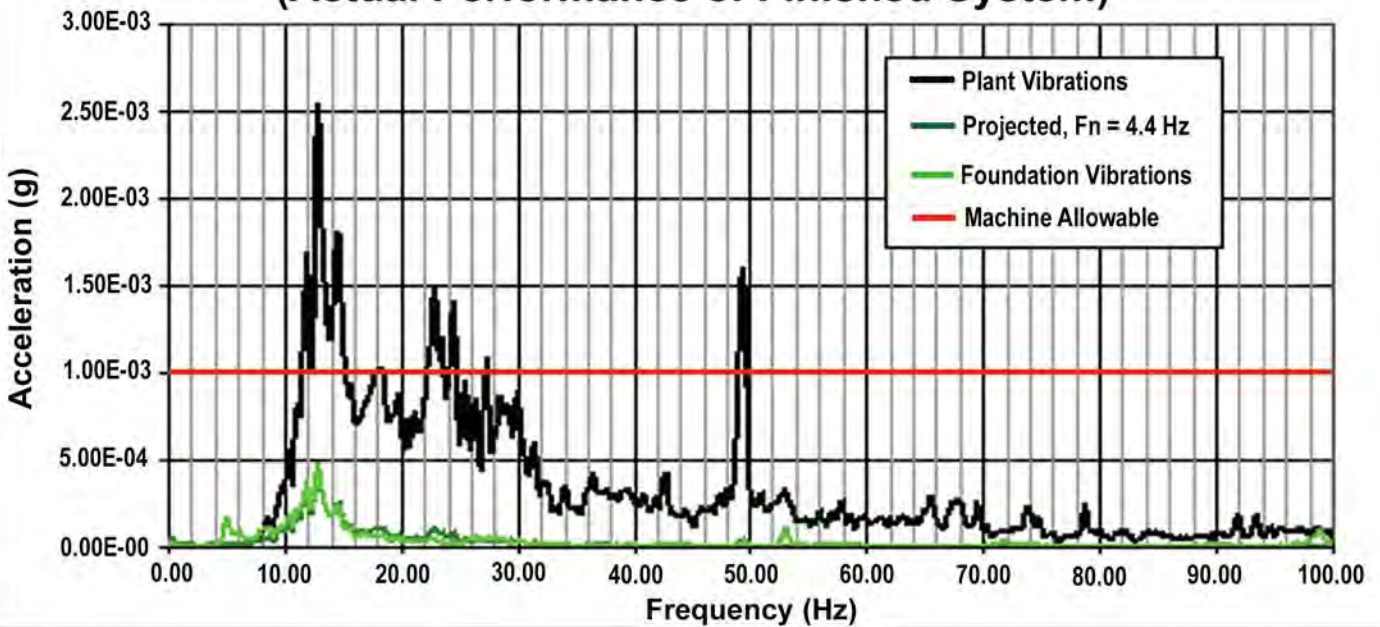



# MACHINE INSTALLATION EXPERTISE SINCE 1935

*Since 1935, UNISORB has been serving the machinery installation needs of all segments of the manufacturing industry. As a part of our commitment to provide the best installation products and services, UNISORB maintains the only industry staff of engineers devoted exclusively to the design and implementation of complete machinery installation systems. From concept to final installation, UNISORB ensures optimum performance of mounted equipment.*



***Depend on UNISORB's years of experience for:***

- *Machinery Mounts*
- *Vibration Isolation Systems*
- *Anchoring/Alignment Systems*
- *Vibration Analysis Services*
- *Professional Engineering Services*
- *Isolated Foundation Design*
- *Advanced Grouting Technologies*



INSTALLATION TECHNOLOGIES

[www.unisorb.com](http://www.unisorb.com)

BOX 1000, JACKSON, MI 49204-1000

888-4-UNISORB • 517-764-6060

ISO-9001 Certified